

CNC TURNING CENTER

VT-36

SUPERIOR PERFORMANCE

- ▶ 15-inch Chuck
- ▶ Up to 7.28-inch Spindle Bore
- ▶ 35 hp / 2000 rpm



Perform a
Full Range
of
Turning
Operations

VIPER



VT-SERIES

36_{BL}

36_{CL}

www.alex-tech.com

Superior Performance

Large Bore with Heavy Duty Turret

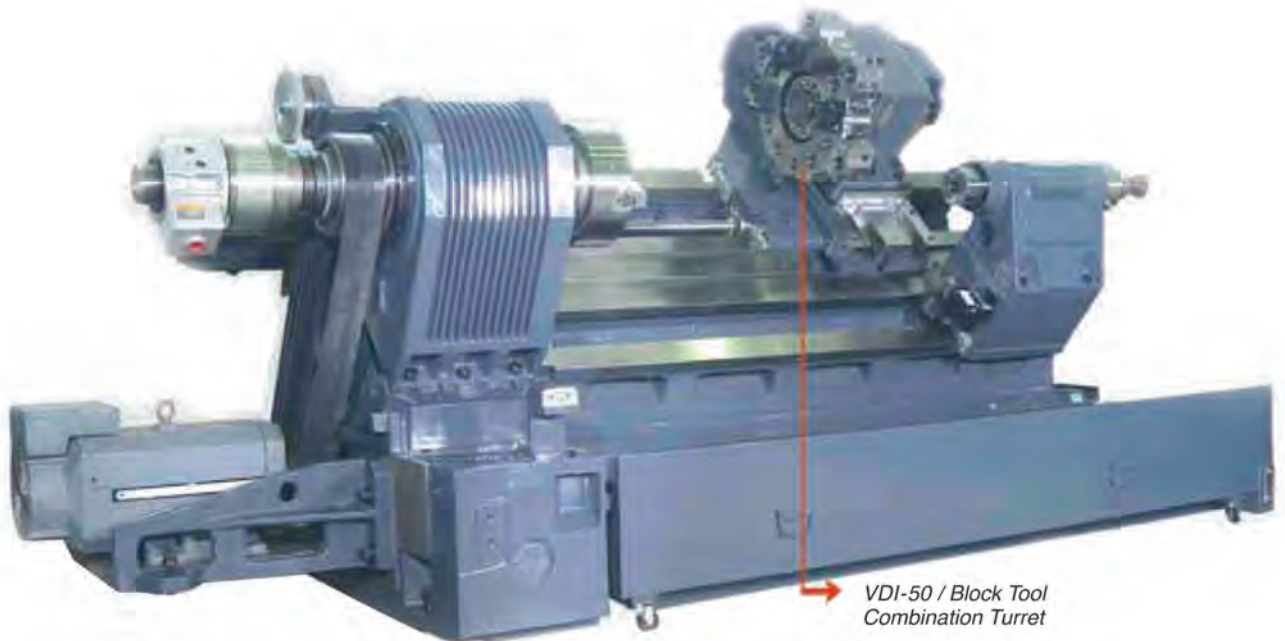

PERFORMANCE FEATURES

- Live Milling
- Sub-Spindle
- VDI-50 Live Turret*
- 50 hp Motor

YOUR MIGHTY VIPER EDGE

From micro-finishing to hard-turning, shaft and flange work pieces, Viper turning centers are known worldwide for their durability and affordability. They're rigid, high-performing, precision-cutting CNC lathes with multi-axis cutting capacity.

The Viper line offers a wide selection of choices, sizes, center distances, specifications and innovative enhancements. Ask for a Viper demo. Then, take your turn.

SOLID CONSTRUCTION

Rigid, one-piece Meehanite cast-iron-bed. Viper turning center construction provides the ultimate in machine tool accuracy and reliability.

A 45° + 15° slant bed design for our **VT-36** gives Viper its exceptional cutting stability facilitating optimal chip removal. Cutting reaction forces are minimized resulting in a high degree of precision. Both X and Y axes on Viper turning centers are supported by oversized hardened and ground box type ways which facilitates exceptionally fast cutting rates.

* Optional accessory.

MACHINE FEATURES

AXIS DRIVE SYSTEMS AND BALL SCREW

Viper drives the axis with maximum radial torque through extremely accurate, zero backlash, large-diameter pretensioned double-nut ball screws. Since the feed screws require high-speed feeding and a reverse capability, our VT-Series employs extremely accurate single-pitch ball screws.



Powerful, robust, ultra-precise Viper ball screws, which are preloaded and double anchored, generate slide way movement in both axes for optimum drive conditions.

CNC CONTROL

An ultra-compact **Fanuc** controller with network capability. It features a CNC printed circuit board integrated with a liquid crystal display, PCMCIA interface and Ethernet communication functions.



High Speed PMC – The PMC process sequence is two and one half times faster than **Fanuc's** previous controllers. Programming capacity has been greatly expanded for sequence control of peripheral equipment enabling monitoring and editing functions to be incorporated on the CNC unit.

High Speed Precision – **Fanuc's** advanced preview control allows looking ahead at multiple parts of the part program and reduces cutting errors in corners and arcs, which in turn results in greater speed and high precision turning.

CRT Selection – 7.2" mono LCD for Oi Mate, 8.4" color LCD for OiT or 10.4" color LCD for OiTD features high brightness. Width vision is optional.

Fault Diagnostics – Should failure occur, cause and recovery are displayed on the CNC display screen enabling a more rapid recovery.

◆ Optional **Mitsubishi** control available.

TURRET SELECTION

STATIC BLOCK TOOL TURRET

A large, rigid, high speed, precision-ground 0.5 second turret-indexing from station to station, and shortest path indexing, makes Viper excellent for production turning. The turret is designed with 12 stations that accept OD tooling, ID tooling and boring tools.

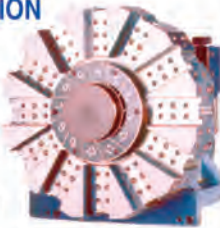

STATIC VDI-50 WITH BLOCK TOOL TURRET

Provides easy set-up and heavy turning for any job requirement. Designed by Alex-Tech.



STATIC VDI-50 TURRET

Provides quick and easy set-up.

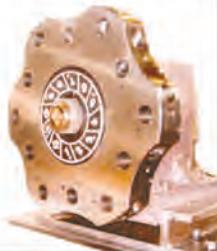

PROGRAMMABLE TAILSTOCK

Viper's highly-rigid tailstock is matched-ground to the headstock mounting surface establishing absolute alignment between the two. With a two-piece modular design and center of gravity in the horizontal plane, the heavy-duty tailstock eliminates machine-induced taper into the workpiece.



Tailstock for larger models with rotary quill.

Viper's tailstock body is positioned by a drive bar which engages with the carriage. Drive bar and tailstock clamping are programmable and tow along. Which means quick set-ups.

3-JAW HYDRAULIC CHUCK

VT-36BL

15" (380mm)

VT-36CL

20" (508mm)



3-Jaw precision.

CHIP REMOVAL

Essential in the production process is proper chip removal. Viper's slant bed construction prevents chips from accumulating on the slides. With our standard roll-out-side chip pan, Viper chip removal is quick and easy. And less floor space is required.



PERFORMANCE OPTIONS

TOOL PRESETTER

With its tool presetter system, Viper is an ideal machine for both short-run and high production environments.

Its tool presetting system assists in reducing set-up time, changing tools and ensures accurate measurement of tool offsets.

The tool presetter allows for various checkpoints throughout the program to obtain optimal part accuracy and finish. These tool offsets are quickly and



accurately measured by the tool presetter probe system.

MANUAL STEADY REST

Steady rests help in turning long and heavy shaft-type workpieces, where cutting loads can create unstable conditions that can cause parts to bend or deflect.



HEAVY PARTS LOADER

An Alex-Tech design, a large capacity parts loader that picks up and unloads parts up to 12" (300mm) / 25 lbs (11kgs).

Available for machines with a chuck size range of 10" (250mm) to 15" (375mm).



TORQUE LIMITER CLUTCH

The clutch disengages when pre-set limiting torque is exceeded and axial movement stops immediately.



A fitted limit switch detects the clutch disengaging movement and signals the drive off. After removal of the overload, the clutch re-engages automatically.

SELF-CENTERING STEADY REST

SMW AutoBlock • Easy installation, Steady Rest consist of four bolts (M16x120mm) and two positioning pins (Ø10 mm).

Centering range without chip guard:

- **SLU3** Ø12 ~ Ø152 (0.47" ~ 5.98")
- **SLU3.1** Ø20 ~ Ø165 (0.79" ~ 6.49")
- **SLU3.2** Ø50 ~ Ø200 (1.96" ~ 7.87")
- **SLU4** Ø30 ~ Ø245 (1.18" ~ 9.64")

Steady Rest optional equipment

- Swarfguard — Spring loaded, self adjusting guard to protect arm rollers against chips.
- Large capacity steady rest may require wider full length splash guard.
- Stroke control (no proximity switch).
- Central oil lubrication for heavy duty cutting.
- Safety valve



BAR FEEDER*

(IEMCA Servo Driven)

Model	Bar Capacity	Stroke
V66E	2.59" (65mm)	49" (1244mm)
V66EL	2.59" (65mm)	61" (15550mm)
VIP-80	3.15" (80mm)	61" (111550mm)
VIP-100	3.93" (100mm)	63" (1600mm)



* Factory order with machine only.

AUTOMATIC DOOR

Push button efficiency, open or close door automatically. VT-36 may be equipped with auto door for models with extended Z-axis travel of 62.6" (1590mm) / 82.2" (2090mm).

Maximum door opening width is 65" (1650 mm) / 85" (2159 mm)

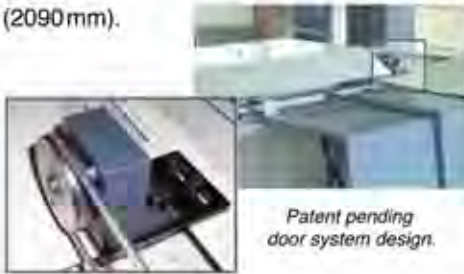

MORE OPTIONS

- Air Chuck
- Automatic gantry loading and unloading system.
- High pressure coolant pump and large capacity coolant tank.
- Tool socket sleeve, inner diameter (I.D.)
- Tool holder, inner diameter (I.D.)
- 1000 psi coolant thru the tool
- Static VDI-50 with block tool
- VDI-50 live turret

TORQUE POWER

VT-36B + Gear Box

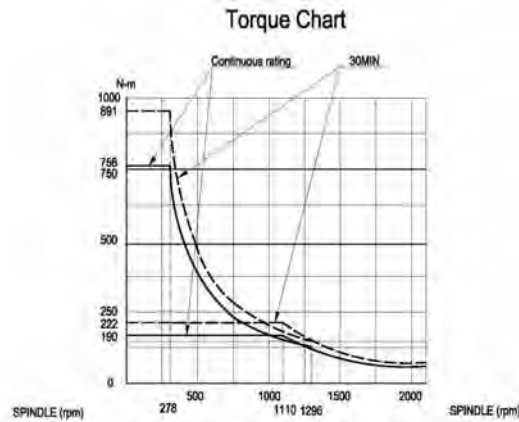

Torque / Horsepower Chart Data			
Spindle Taper	A2-11	Spindle Motor	FANUC a22/7000
ISO	-	Motor Output	22/26 kw
		Gear Ratio	1:4
Spindle Speed	(L)1-1100 (H)1100-2000 RPM	Pulley Ratio	1/1.35

30 Min. Rating = (- - -)
Continuous Rating = (—)

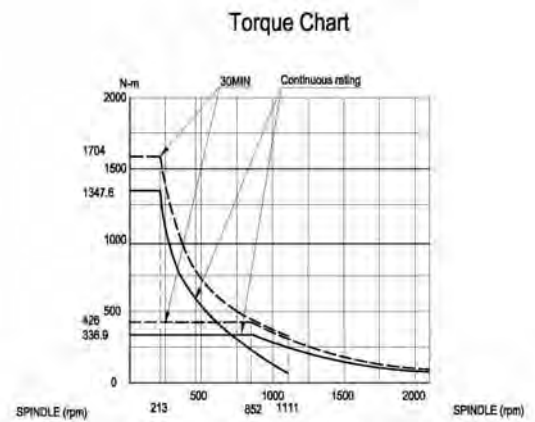

Torque / Horsepower Chart Data			
Spindle Taper	A2-11	Spindle Motor	FANUC a30/6000
ISO	-	Motor Output	30/37 kw
		Gear Ratio	1:4
Spindle Speed	(L)1-1111 (H)1-2000 RPM	Pulley Ratio	1/1.35

VT-36C + Gear Box

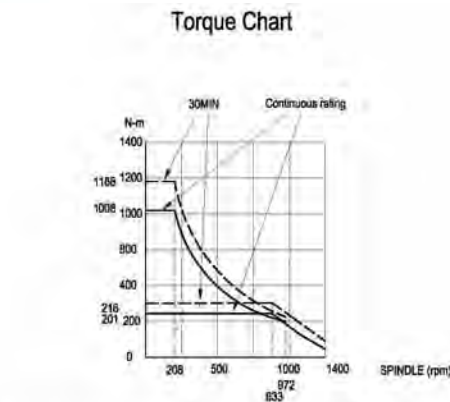

Torque / Horsepower Chart Data			
Spindle Taper	A2-15	Spindle Motor	FANUC a22/7000
ISO	-	Motor Output	22/26 kw
		Gear Ratio	1:4 (Barnafalodi CE-13)
Spindle Speed	(L)1-833 (H)1-1000 RPM	Pulley Ratio	200/360=0.55=1:1.8

30 Min. Rating = (- - -)
Continuous Rating = (—)

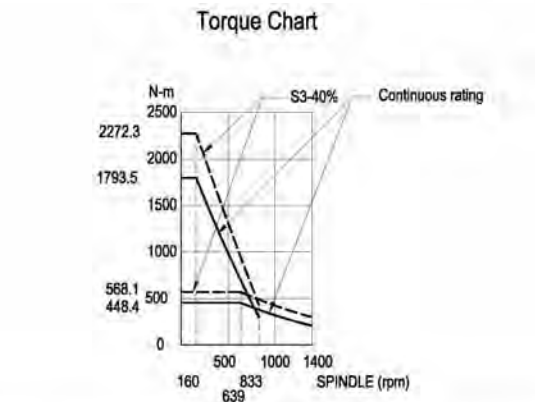

Torque / Horsepower Chart Data			
Spindle Taper	A2-15	Spindle Motor	FANUC a30/6000
ISO	-	Motor Output	30/37 kw
		Gear Ratio	1:4
Spindle Speed	(L)1-833 (H)1-1000 RPM	Pulley Ratio	1:1.8

TURRET TOOLING

Static Block Tool

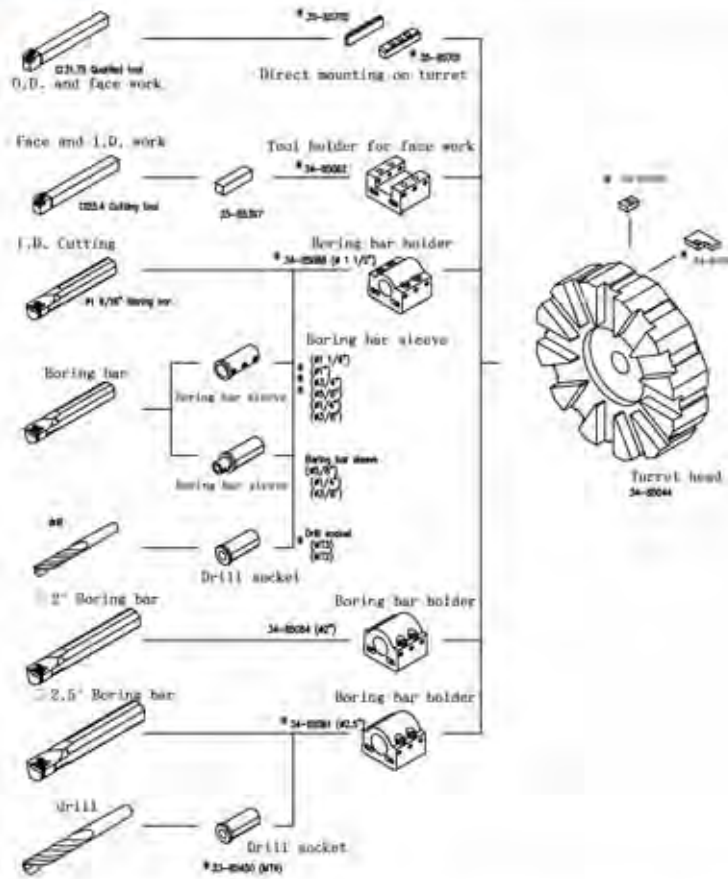

VDI 50 Live

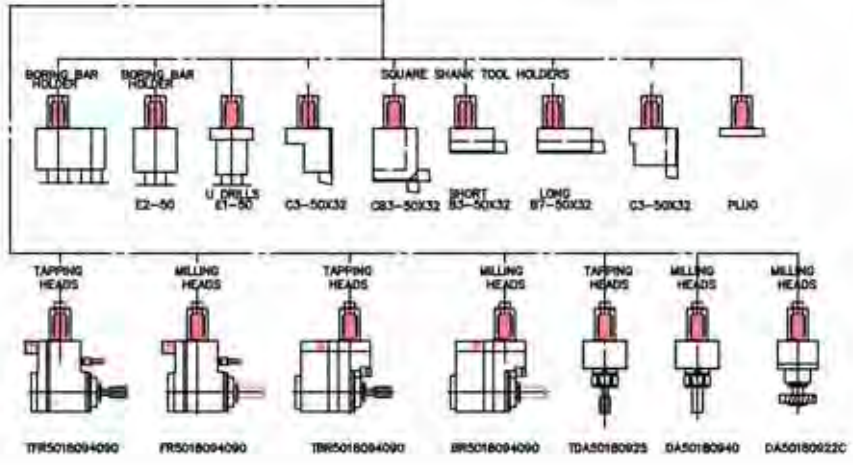
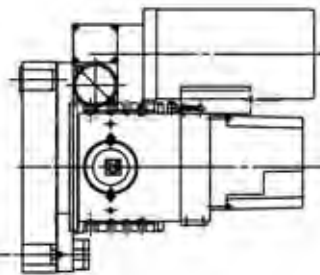

CUTTING CAPACITY

Static Block Tool

VDI-50 Live

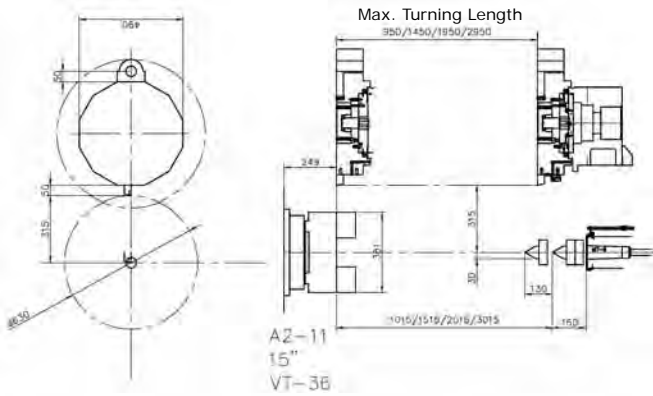

SAUTER VDI50 PC0=420
COUPLING DIN1809
0.5.436.225/12T
AXIAL LIVE TURRET

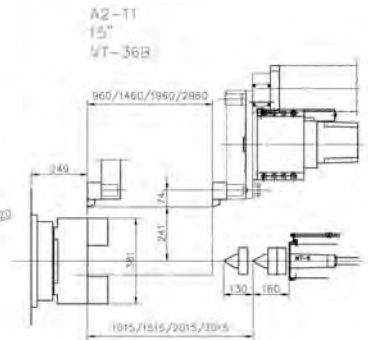
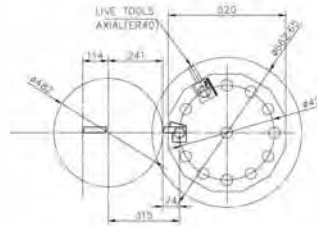

Static Block Tool

VDI-50 Live

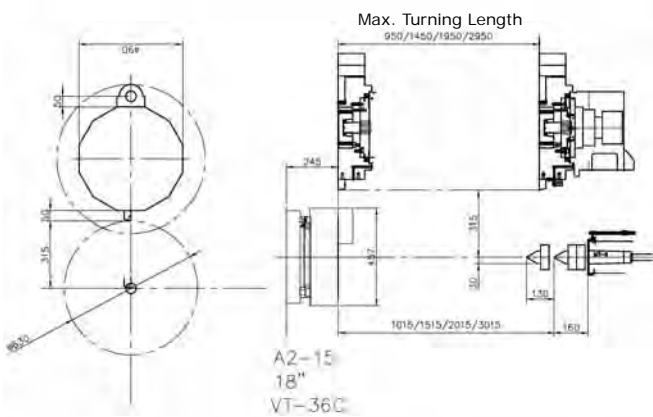

SAUTER VDI50 PC0=420
COUPLING DIN1809
0.5.436.225/12T
AXIAL LIVE TURRET

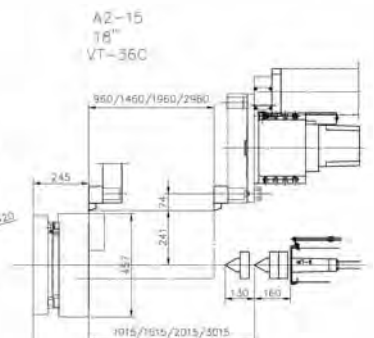
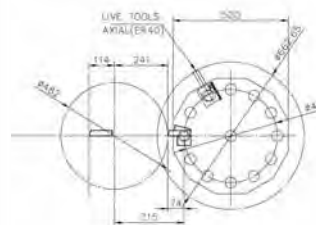

Machine Specifications

ITEM	UNIT	VT-36B		VT-36C	
		1000 / 1500 / 2000 / 3000		1000 / 1500 / 2000 / 3000	
CAPACITY					
Swing over Z way cover	mm (inch)	800 (31.5)			
Max. turning diameter	mm (inch)	630 (24.8)			
Swing over cross slide	mm (inch)	630 (24.8)			
Max. turning length	mm (inch)	950 (37.4) / 1450 (57) / 1950 (76.7) / 2950 (116.1)			
Slide way slant angle	degree	45 +15			
TRAVEL					
X-axis travel	mm (inch)	315 (12.4) + 30 (1.18)			
Z-axis travel	mm (inch)	950 (37.4) / 1450 (57) / 1950 (76.7) / 2950 (116.1)			
SPINDLE					
Type of spindle nose	ISO	A2-11		A2-15	
Chuck diameter and type*	mm (inch)	380 (15)		457 (18)	
Spindle bearing inner diameter	mm (inch)	180 (7.08)		240 (9.44)	
Through spindle hole diameter	mm (inch)	131(5.15)		185(7.28)	
Through bar capacity	mm (inch)	115 (4.52)		159(6.25)	
Spindle drive motor (cont./30 min.)	kW (hp)	26(35)		26(35)	
Spindle speed range	rpm	2000		1000	
TURRET					
Number of tool stations	—	12(SW=490)/10*			
Turret type	—	STATIC / VDI-50*			
Turret indexing time	second	0.9			
Shank height of square tool	mm (inch)	32 (1.26)			
Shank diameter for boring bar	mm (inch)	60 (2.36)			
FEEDRATE					
Rapid traverse rate X-axis	M/min. (ipm)	20 (787)			
Rapid traverse rate Z-axis	M/min. (ipm)	24 (944)			
Ballscrew diameter of X-axis	mm (inch)	32 (1.26)			
Ballscrew diameter of Z-axis	mm (inch)	40 (1.57)			
TAILSTOCK					
Tailstock travel	mm (inch)	1015 (40) / 1515 (59.6) / 2015 (79.3) / 3015 (118.7)			
Tailstock spindle diameter	mm (inch)	150 (5.9)			
Tailstock spindle travel	mm (inch)	130 (5.19)			
Taper hole of tailstock spindle	—	MT-6			
REMARKS					
Coolant pump motor	kW (hp)	0.6 (0.75)			
Coolant tank capacity	L (gal)	216 (273) / 270 (341) / 324 (409) / 378 (477)			
Floor space (W x L)	mm (inch)	x1000 = 2,450 x 5,450 x2000 = 2,450 x 6,450 x1500 = 2,450 x 5,950 x3000 = 2,450 x 7,450			
Machine weight	Kg (lb)	10,600 (23,350) 12,000 (26,400) 11,300 (24,900) 13,400 (29,480)			

Design and specifications are subject to change without prior notice.

* Optional Accessory | ** Factory order only

Machine Dimensions VT-36

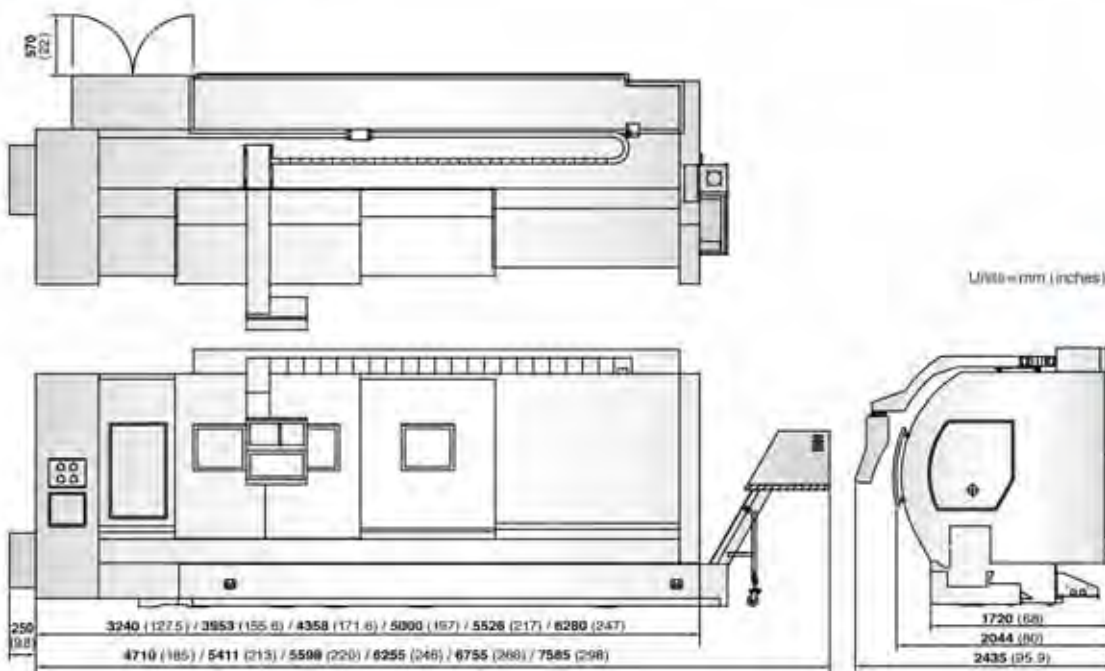

Standard Features

- Auto Lubrication System
- Block for Base
- Cooling System
- Coolant Tank Guard
- Chip Conveyor
- Fluid Bearing Way System
- Foot Switch for Spindle Clamp / Unclamp
- Hard Jaw (1-Set)
- Heat Exchange for Electrical Cabinet
- Hydraulic Adjustment System
- Hydraulic Chuck, 3-Jaw 15"
- Lubrication Monitoring System
- Soft Jaw (1-Set)
- Tool box with Hand Tool
- Work Light

Optional Accessories

- Air Chuck
- Automatic Gantry Loading and Unloading System
- Bar Feeder Interface**
- Chip Conveyor
- Coolant Through Tool up to 1,000 psi
- Cut-Off Attachment
- Drilling and Milling Attachment 3000 rpm
- Front Parts Catcher
- Grinding and Milling Attachment 10,000 rpm
- Heavy Parts Loader
- High Pressure Coolant Pump and Large Capacity Tank
- Live Tooling
- Live VDI-50 Turret with Block Tool Turret
- Manual Guide i
- Rear Chuck Flange
- Rear Chuck Adapter
- Rear Manual Spindle Mounted Chuck
- Rear Parts Catcher
- Static VDI-50 Turret
- Static VDI-50 with Block Tool Turret
- Self-Centering Steady Rest-SMW Autoblok
- Tool Presetter
- Torque Limiter Clutch



伍將機械工業股份有限公司

ALEX-TECH MACHINERY INDUSTRIAL CO., LTD.

No. 5, Chun An Rd., Shenggang District,

Taichung City 429, Taiwan

Tel:886-4-25626039

Fax:886-4-25626040

http://www.alex-tech.com

E-mail:alextech@ms24.hinet.net

Catalog_VT-36-2012.12.v3